

## SPECIFICATIONS

Model Name	4T-B60CP1X	Output Terminal*3	Digital audio output x1, USB power supply x 1, $\Phi$ 3.5mm audio out (headphone) x 1,	
Operating hours	16 hours / 7 days	Input/Output Terminal*3	LAN port, USB x 1, Service only ( $\Phi$ 3.5 mm jack)	
Installation	Landscape / Portrait *2	Mounting	VESA (4 points)*5300 x 200 mm pitch	
Sound output	10w x 2	Power supply	110V - 240V AC, 50/60Hz	
LCD panel	60 inch widescreen (152.7cm diagonal) TFT LCD	Power Consumption	185 W	
Max. Resolution	3840 x 2160 pixels	AC cord	3m	
Max. Display Colours (approx.)	16.77 million colours	Environmental Conditions	Operating Temperature	0°C to 40°C *7
Pixel Pitch (H x V)	0.3465 x 0.3465 mm		Operating Humidity	20% to 80% RH (no condensation)
Brightness*1	300cd/ m <sup>2</sup> typ.	Dimensions*6 (W x D x H) (without Stand)	1358 x 300 x 864 mm (1358 x 83 x 790 mm)	
Contrast Ratio*1	4000 : 1 typ.	Weight (w/o stand)	18.5 kg ( 17.5 kg)	
Viewing Angle (H/V)	176° / 176° (CR≥10)	Main Accessories	Remote controller x 1, AAA manganese battery x 2, Stand x 1 set, HDMI locking clamp x 3, USB locking wire x 5	
Active Screen Area (W x H)	(Approx.) 1330.6 x 748.4 mm (42.386"x 29.465")	Option (sold separately)	AN-MMSTP1 / FS2B2	
Response Time	8.8 ms (gray to gray, avg.)			
Backlight	LED, direct type			
Input Terminal*3	HDMI**4 x 3, RCA video x 1, RCA L/R x 1, Antenna (DIN type) x1			

\*1 Brightness and contrast ratio depend on input mode and other picture settings. Brightness level will decrease slightly over the lifetime of the product. Due to the physical limitations of the equipment, it is not possible to maintain a precisely constant level of brightness. \*2 OSD menu does not rotate. Remains landscape position. \*3 Use a commercially available connection cable for PC and other video connections. \*4 For both PC and AV components. \*5 To use the VESA-standard mounting bracket, use M6 screws that are 8 to 10mm plus the thickness of the bracket. \*6 Display only, not including protrusions. \*7 When using portrait condition, keep it within +/- 20 degrees. When using Multi-monitor and portrait condition, these operating temperature: 0 to 35°C."

### Dimensions/Weight (1unit)

	(w/ Stand)	(w/o Stand)
Dimensions (W x H x D) (mm)	1,358 x 864 x 300	1,358 x 790 x 83
Weight (kg)	18.5	17.5

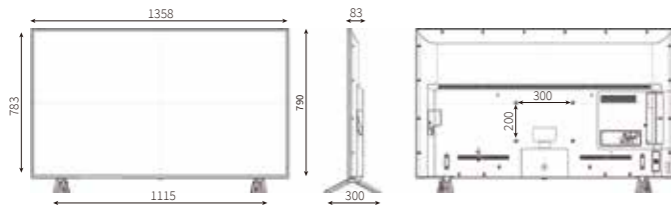

### Dimensions/Weight (4unit)

Dimensions (W x H x D) (mm)	2718 X 2266 (max) x 950
Weight (kg) approx.	117

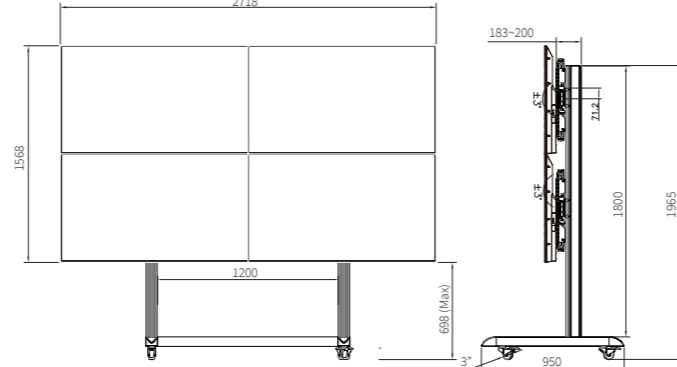

### Dimensions/Weight (Multi-monitor Floor stand)

Dimensions (W x H x D) (mm)	1010~1970 x (1670~1970) x 950
Weight (kg) approx.	43

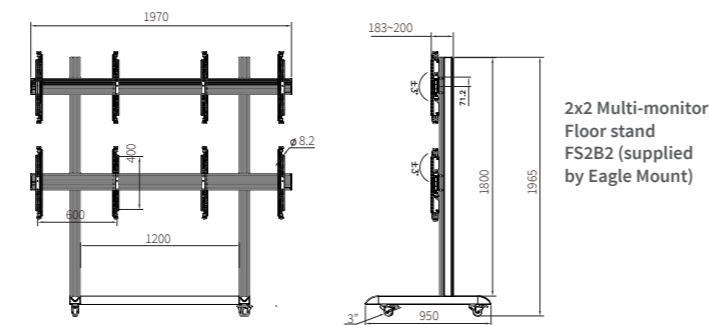

### Terminals



- ① Antenna
  - ② USB Port (Power Supply)
  - ③ USB Port (2.0)
  - ④ HDMI 1
  - ⑤ HDMI 2
  - ⑥ HDMI 3
  - ⑦ Headphone/Audio Out(L/R)
  - ⑧ Digital Audio Output
  - ⑨ LAN
  - ⑩ AV IN (Video, L/R)
  - ⑪ Service Only (RS232C input\*)
- \*Required RS232C converter

Design and Specifications are current as of July 2020, but subject to change without prior notice. Actual colours may differ slightly in this catalogue. For details, please consult with SHARP Service center, your local authorized Sharp dealer or representative.

# SHARP

**SHARP ELECTRONICS (MALAYSIA) SDN. BHD.** (No.356997-H)  
 No.1A, Persiaran Kuala Langat, Section 27, 40400 Shah Alam, Selangor Darul Ehsan.  
 Product Enquiry: 03 5102 5369 Service Enquiry: 1 800 888 678 (Toll Free)  
 Email: productinfo@my.sharp-world.com | [Sharp Malaysia](#) | my.sharp



# SHARP

## BIG AQUOS

Multi-Monitor For All Your Business Needs



MESMERISE YOUR SENSES WITH  
 A STUNNING VISUAL EXPERIENCE

# BIG AQUOS

LARGE, HIGH-QUALITY 4K SCREENS  
GREATER VISUAL DETAILS,  
MORE VIVID COLOURS



**DVB-T2**  
TV broadcasting receiver

▶ **HIGH QUALITY 4K DISPLAY**

Up-converts from HD/2K sources to 4K. Contrast and colour are optimised for best experience.

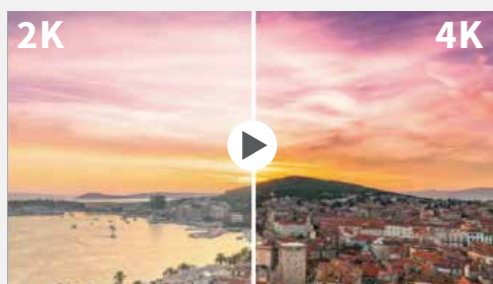

▶ **VIVID COLOUR DISPLAY**

Visual display made more stunning with 16.77 million colours in 3840 x 2160 pixels in a 60-inch monitor.



▶ **MASSIVE 120-INCH DISPLAY**

Install the 120-inch easily and double the size of your display while capturing every detail, beautifully.

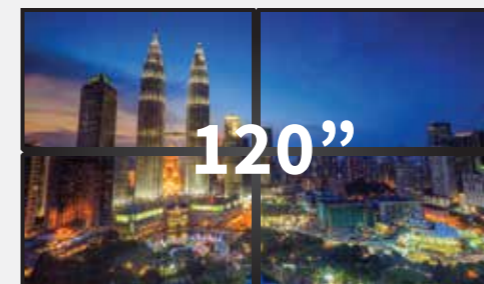

▶ **MADE IN JAPAN PANEL**

The panel is assembled in Japan with quality assured. It has passed over 7 rigorous tests conducted on it.



**7 Shields Protection**  
All SHARP products have passed strict Japanese quality standards. SHARP TVs have been proven to operate safely and are highly durable under various circumstances.

• Contents displayed and player are not included in the product • Equipment for video conferencing is not included • Sold separately: Multi-monitor Floor Stand (FS2B2)

# PRESENTATION MADE EASY WITH SUPERB FEATURES

## AUTO CONTENT MANAGEMENT

Show customers your best offers at your preferred time to maximise impact and interest. Via the single TV set function, the content display times can be pre-set in advance. For multi-monitors, no advance pre-set time feature is available.

Breakfast / 7:00-11:00



Lunch / 11:00-13:00



Afternoon Tea / 13:00-15:00



Dinner / 17:00-21:00



Bar / 21:00-24:00



Contents will auto-switch according to the built-in clock. All you have to prepare is a USB pen drive.

\* TV must be turned on

Recommended Format	Picture	JPEG / PNG / BMP
	Audio	MP3 / AAC / WMA

# VARIOUS SOLUTIONS FOR DIFFERENT BUSINESS NEEDS

Four split screens can be combined into one image on this Multi-monitor, with the **Multi-monitor Setting Tool**.



## HOTELS

**Big-screen clarity** for the convenience of guests

Keep guests well-informed throughout the hotel area with the latest news and updates, with Sharp's large screen, brilliant monitor.



## EVENTS

**Maximise** your engagement with patrons

Ensure your events are a success with large monitors that showcase content in an exciting way.



## EDUCATION

Large screens provide **greater details** for ease of teaching

Capture the attention of students with large screens that present information in an easily-understood, interesting manner.



## MALLS & RETAIL SHOPS

Large screens attract and **hold the attention** of shoppers

Sharp's high-quality screens will help you grab the attention of shoppers and delight them with attractive product information.



## BUSINESSES

**Improve** employee engagement and interaction

Enhance communication with your employees with large screens that make meetings and info-sharing more engaging.



## GOVERNMENT AGENCIES

Large screens make it easier to provide **vital information** to the public

Sharp's brilliant, big screens enable important information to be conveyed to the public in an effective, eye-catching way.

# EASY SET-UP FOR MAXIMUM EXPOSURE



Multi-Monitor Floor Stand



Retractable Locking Caster Wheels

## AMAZE YOUR CLIENTS WITH THE EXTRA-LARGE, BRILLIANT DISPLAY WITH A PORTABLE STAND

Set up Sharp's large monitor with ease, at your events and meetings. The angle of the monitor can be adjusted quickly and easily according to your preference, for maximum exposure.



### CONVENIENT ASSIST FOR SETTINGS/ADJUSTMENTS

The Multi-monitor Setting Tool helps you set up and adjust the gap parity among the Multi-monitors.



## MULTI-MONITOR COMBINATION

Flexible installment with less investment-Portrait to Multi-monitor.

1 X 2	2 X 1	2 X 3	3 X 1	1 X 3	3 X 3
1-1 1-2	1-1 2-1 1-1 2-2	1-1 2-1 1-2 2-2 1-3 2-3	1-1 2-1 3-1 1-2 2-2 3-2 1-1 2-1 3-1 1-2 2-2 3-2	1-1 1-2 1-3	1-1 2-1 3-1 1-2 2-2 3-2 1-3 2-3 3-3

## HOTEL / F&B RETAIL SOLUTION

### VERSATILE CONNECTIONS FOR DIFFERENT BUSINESSES



WiFi (wireless)

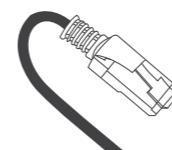

LAN (wired)

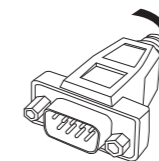

RS-232C\* (wired)  
\*Requires a RS-232C converter

\*RS232C converter  
QCNWGA204WJPZ  
(sold separately)

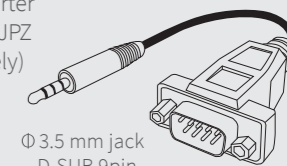

Φ 3.5 mm jack  
D-SUB 9pin

### EASY CONVENIENCE WITH USB CLONING

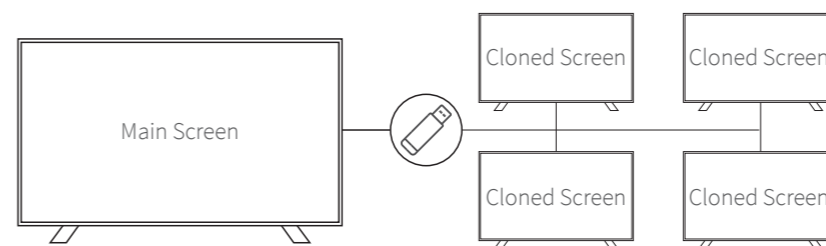

Just set up Sharp's Big-Screen Monitor once, and save to your USB. You can then set up as many large screens as you like by simply plugging in the USB. There is no need to set up the monitors one by one using the remote control.

## CONVENIENT TOOLS FOR BUSINESS USE

### USB LOCKING WIRE PREVENTS USB THEFT

A USB locking wire ensures that your device stays in place and will not be accidentally dislodged. Importantly, it prevents USB theft.

USB locking wire prevents USB theft



5pcs



### PREVENT HDMI DISCONNECTION

Ensure no interruption to your video and audio signals for a smooth and continuous picture display and sound output. A HDMI locking clamp prevents HDMI disconnection.

HDMI locking clamp prevents HDMI disconnection

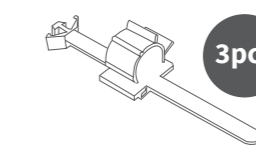

3pcs



### SETTING UP THE DISPLAY

#### Detachable LED lens

CP1X has a pop-out LED lens to receive signals, better.



Only with a Phillips screwdriver

