

# SHARP

Be Original.

## MX-8090N MX-7090N

Digital Full Colour Multifunctional System

Meet All Your Colour Printing Needs with Ease,  
No Matter the Volume



# Making In-House Printing Fast, Easy, and Powerful



## High Productivity

The MX-8090N/7090N's print engine handles large-volume colour jobs with ease. It offers outstanding productivity, thanks to its large paper capacity, high-speed DSPF, and smart systems that prevent paper mis-feeds and minimise downtime.

When you need to print a business proposal or strategy paper right now, the MX-8090N/7090N gets the job done fast.



## Superb Image Quality

Stable image quality means high-speed, large-volume jobs come out with consistently high quality, from first page to last. The full-length guaranteed print range ensures that you get superb image quality over the entire printable area.

Enjoy a consistently high level of print quality, even for demanding, large-volume jobs.



The MX-8090N/7090N is built for fast, high-volume printing in large-scale settings. Whether at a large company, government office, university, or research centre, it produces beautiful colour documents with ease. Refined Sharp MFP technology delivers an optimal balance of productivity, quality, and user-friendly operation. You can do short-run documents for presentations, press releases, or marketing materials. Or do bulk printing of booklets, pamphlets, and in-house magazines. A powerful Fiery® server option adds further versatility to an MFP that can already handle a wide variety of documents. With the MX-8090N/7090N, you also save the cost of outsourcing your print jobs.

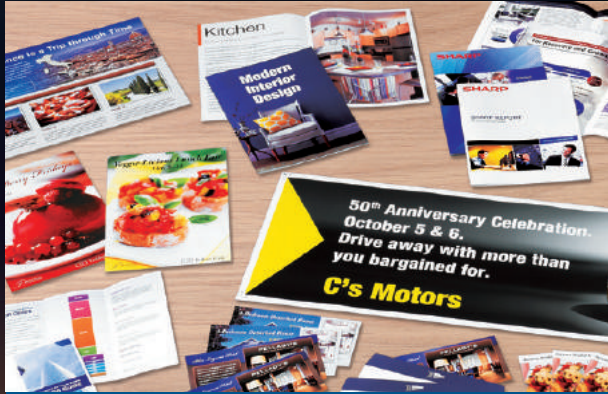

## Enhanced Versatility

The MX-8090N/7090N has all the features you need in a CRD, including a wide range of paper feeding and finishing options. You can also pair the MFP with a Fiery server—external or embedded—to get the advantage of more efficient print management.

Thanks to precise colour management and a range of finisher options, you get superb-looking documents every time.



## Smooth Operation

Thanks to a large 15.4-inch LCD and the same user-friendly UI found on other Sharp MFPs, it's easy and intuitive to operate the MX-8090N/7090N. This MFP also features OCR capability and direct printing of Microsoft® Offices files, meeting the needs of office users.

Anyone—including newcomers to your team—will be able to operate the MFP and take advantage of its advanced features in no time.



# High Productivity

## Super-Efficient Colour and B/W Output

The MX-8090N/7090N delivers a fast output of 80/70 ppm\* in B/W and in full colour. The first copy comes out in just 3.7/4.0 seconds in B/W and 5.1/5.6 seconds in full colour, saving you valuable time when performing multiple short-run jobs.

\* A4 (8 1/2" x 11"), long-edge feeding

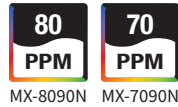

## High-Efficiency Scanning

The MX-8090N/7090N comes equipped with a highly efficient 150-sheet DSPF (duplex single pass feeder). This scans both pages of two-sided documents in one pass. With a scanning speed of up to 100 opm\* (one-sided) or 200 opm\* (two-sided), this MFP can finish even large projects quickly.

\* Originals per minute; when feeding A4 (8 1/2" x 11") sheets



## Front-to-Back Registration

Based on feedback from two paper-position sensors located in the paper path, the MX-8090N/7090N employs an image shift function to automatically adjust the position of printed images with respect to the edges of a page. This precise front-to-back registration ensures exact correspondence of the printed material, so that consistently high levels of quality can be achieved when producing leaflets, brochures, and other documents—including those with two-sided double-page spreads or those that are to be saddle stitched and trimmed. Users can also manually adjust vertical/horizontal ratio\* and position settings to achieve even more precise front-to-back registration.

\* Available only for Sharp printer driver.

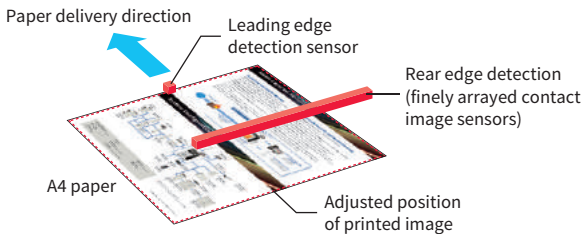

## Large Paper Capacity

While the MX-8090N/7090N holds 3,100 sheets of paper, this standard capacity can be expanded to meet the needs of high-volume jobs. Adding an optional 500-sheet Multi Bypass Tray and two 5,000-sheet (2,500 x 2) Large Capacity Trays boosts capacity to 13,500 sheets and enables a maximum 9-way automatic paper feed. And when a tray runs out of paper, the Auto Tray Switching function automatically switches to another tray with the same-sized paper.

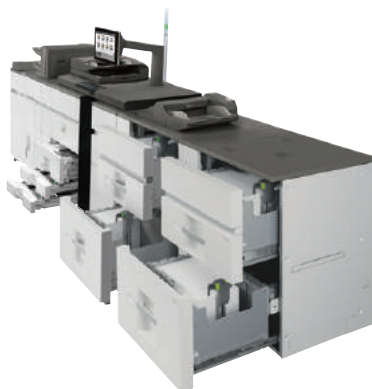

## Limitless Operation

There's no need to stop the MX-8090N/7090N during large-volume copy/print jobs when the toner cartridge needs changing or when a paper tray needs replenishing. This means minimum downtime for the MFP during busy workloads. The MX-8090N/7090N can use toner from the large intermediate toner hopper to continue printing while the empty toner cartridge is replaced with a new one. Paper trays not currently in use can also be replenished without stopping the machine.



Printing continues during toner cartridge replacement

## Curl Correction

For reliable output of two-sided copies and prints, the MX-8090N/7090N provides built-in curl correction to uncurl paper just after transfer. And for added stability, the optional Curl Correction Unit uses top and bottom rollers to apply pressure to convex and concave curls, preventing paper from warping before it goes to the finisher.

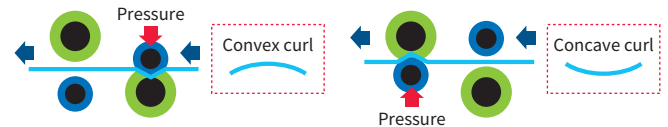

## Triple Air-Feed System

The Triple Air-Feed System on the optional 5,000-sheet MX-LC13 N Large Capacity Trays reliably separates and feeds in paper to facilitate jam-free operation and minimise downtime. Capable of supporting a wide range of paper types, this system employs air-feed technology and three precisely directed air flows for maximum reliability and proper paper handling.

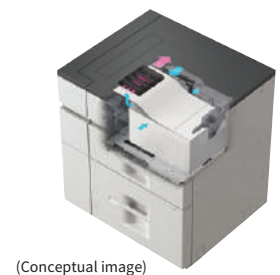
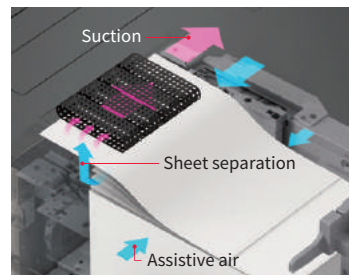

(Conceptual image)

## Multi-Feed Detection System

A precision-engineered Multi-Feed Detection System employs ultrasonic technology and separation rollers for double-fed paper to detect and prevent misfeeds from the paper feed section for maximum uptime.



# Stable Image Quality

## Breathtaking Image Quality

### Full-Length Guaranteed Print Range

With the MX-8090N/7090N, you don't have to worry about print quality degrading on the edges of your documents. The guaranteed print area reaches right to the edges of the printable area. This means that superb print quality is assured across the entire printable length of 319 mm.

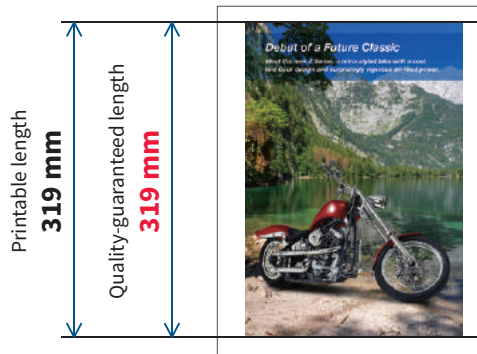

### High-Resolution Output

The MX-8090N/7090N employs 8-bit image processing to deliver razor-sharp 1,200 x 1,200 dpi printing—without sacrificing output speed. Digital smoothing technology enhances the print and copy resolution to the equivalent of 9,600 x 600 dpi for smooth reproduction of fine lines. Fine-grained photographs, detailed illustrations and graphs, and small text come out crisp and clear.

### Dot Screening Technique

In addition to conventional line screening, the MX-8090N/7090N employs the dot screening technique—typically found on offset printers—for colour and greyscale printing. Thanks to dot screening, the MX-8090N/7090N can emulate the high-quality printing of offset printers.

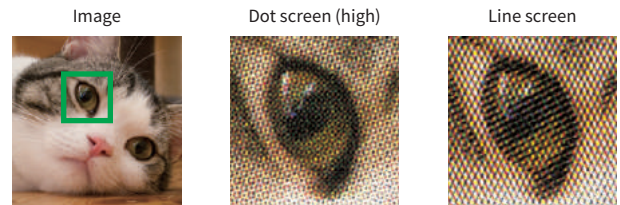

### Mycrostoner-HG3

Third-generation Mycrostoner-HG3 (High Grade) expands the colour reproducibility range for a more natural rendering of clear blue skies, emerald green oceans, and other colour images. And the smaller particle size of the toner and the carrier allows for reduced graininess and clear reproduction of fine lines, fine text, and halftone colours.

### Adobe® PostScript® 3™

The MX-8090N/7090N supports genuine Adobe PostScript 3 for better graphics handling. Complex colour graphics can be printed out in a short time with minimal error, and multiple colour spaces such as RGB, CMYK, and Lab can be used.

## Advanced Technologies to Maintain High Image Quality

### Developer Refresh System

In order to achieve consistent image quality from first page to last, Sharp developed the Developer Refresh System. In this system, toner and carrier are delivered to the developing unit at the same time. By discharging old developer little by little and continuously replacing it with new developer, this system prevents developer deterioration, ensuring stable print quality over the long term.

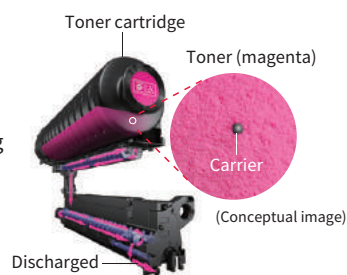

### Auto Process Control

To maintain a consistently high image quality during large-volume print jobs, the MX-8090N/7090N employs an enhanced periodic colour calibration system. Image density sensors monitor image consistency to minimise colour variance between pages. As an added advantage, the MFP makes the necessary colour adjustments without stopping the print job, ensuring time-efficient printing.

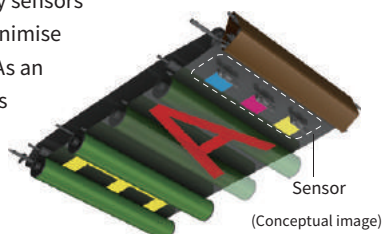

### Precise Colour Registration

To meet the demands for high image quality, accurate colour registration, and stable output, the MX-8090N/7090N employs functions that automatically make the right adjustments at the right time without sacrificing print speed. These functions enable the MFP to deliver highly precise printing and stable colour quality, so that a consistently high level of print quality and productivity is maintained over the long run, from first page to last.

- When printing large numbers of multi-page documents, the MX-8090N/7090N automatically adjusts the print position so that each of the CMYK colours is printed at the correct registration.
- The MX-8090N/7090N's registration sensors precisely detect the position of registration patches printed on the transfer belt. These measurements are then used to make minute adjustments—when necessary—of the print position for each CMYK colour.
- The temperature inside the machine is measured by sensors in key areas of the MFP, such as the LSU (laser scanning unit) and paper-transfer section. The MFP uses this information to make automatic adjustments before print quality can be affected by temperature changes.
- For even greater precision, a sensor detects any skewing of the laser beam that goes from the LSU to the photosensitive drum, so that the MFP can make automatic adjustments to eliminate such skewing.

# Enhanced Versatility

## Versatile Paper Handling

The MX-8090N/7090N accommodates a wide variety of sizes, weights, and types of paper, expanding the range of possible printing applications.

- **Paper Sizes:** The MX-8090N/7090N supports an extensive range of standard paper sizes from A5 to SRA3/A3 wide (5 1/2" x 8 1/2" to 13" x 19"), along with custom paper sizes up to 330 x 488 mm (13" x 19.2"). Thanks to its printable area of 319 x 1,292 mm, this MFP enables full-bleed printing of an A3 image with crop marks or two A4 images with crop marks.
- **Paper Weights:** The MX-8090N/7090N handles paper as thin as 55 g/m<sup>2</sup> and as thick as 300 g/m<sup>2</sup>. Duplexing is possible for paper ranging from 60 g/m<sup>2</sup> to 300 g/m<sup>2</sup>.
- **Paper Types:** In addition to plain paper, the MX-8090N/7090N accommodates a number of other paper types—including coated, textured, or embossed paper—as well as envelopes. This gives users the flexibility to fulfil diverse printing needs.

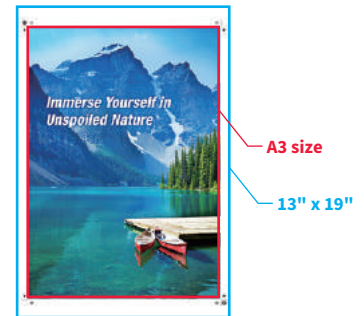

## Professional-Quality In-Line Finishing Options

### Stapling and Punching

With a maximum output capacity of 4,250 sheets, handy Finishers provide three stapling positions—front corner, rear corner, and two-point side—for up to 100 sheets per set. Two-to-four-hole punching is available as an option.

#### • Stapling Positions



#### • Punching Positions



### Full-Bleed Booklet Making

The MX-8090N/7090N's edge-to-edge printing feature ensures printing to the top and bottom edges of the page, so that only the void areas of the lead and trail edges need to be trimmed for a full-bleed effect. This feature allows production of full-bleed A4-size booklets up to 80 pages in length. Using this function with the Saddle Stitch Finisher and Trimming Module enables users to automatically create high-quality, professional-looking booklets in-line, helping to reduce both outsourcing costs and production times.

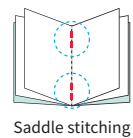

The MX-FN22 Saddle Stitch Finisher staples and folds sets of documents up to 20 sheets in length.

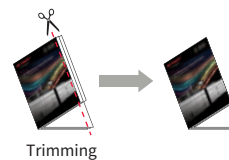

The MX-TM10 Trimming Module trims the lead and trail edges of a saddle-stitched document to give it a beautifully consistent finish.



### A Variety of Folds

The MX-8090N/7090N automates various types of folding, such as z-folding and c-folding, for efficient production of direct mail, brochures, and more.

\*1: For A3- and A4-size (short-edge feed) paper.

\*2: Z-fold and half-fold pages are ejected from the finisher (MX-FN22/FN21).

\*3: For A4-size (short-edge feed) paper.

\*4: For A3 wide-, A3-, and A4-size (short-edge feed) paper.

#### • Fold Variations

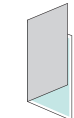
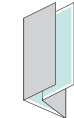
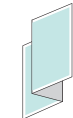
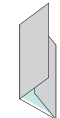

MX-FD10 Folding Unit

### Insertion

For truly professional results, the Inserter can add pre-printed covers and insert paper up to 220 g/m<sup>2</sup> to documents before final finishing. Two input trays, each with a capacity of 200 sheets, make it possible to feed in two different types of paper.

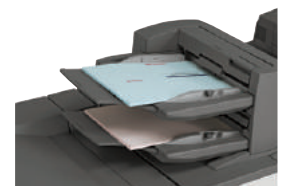
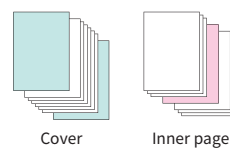

### Long-Paper (Banner) Printing\*

The MX-LT10 Long Paper Feeding Tray accommodates extra-long paper up to 1,300 mm—expanding the range of print products to include panoramic pictures, large display-window ads, banner signs, and more.



\* Contact a Sharp customer representative for details on using this function.

## Fiery® Server for Outstanding Quality and Efficiency

Paired with an industry-leading EFI™ Fiery server, the MX-8090N/7090N becomes a powerful integrated solution for managing professional in-plant and busy on-demand printing environments.

Two options are available to match your needs: the multifunctional MX-PE13 external server, or the more affordable basic MX-PE14 embedded server.



### Centralised Control and Automated Management

The MX-PE13/PE14 Fiery Server offers a centralised solution that features the award-winning Command WorkStation® with a de facto industry-standard print job management user interface. It's intuitively easy to preview jobs, check their progress, and do reprints. With the MX-PE13, Command WorkStation is fully integrated at the MFP's control panel. This allows you to monitor, control, and troubleshoot production directly from the touchscreen.



An optional touch pad (part of the MX-PX13 Fiery Interface Kit for the MX-PE13) allows you to control an on-screen mouse

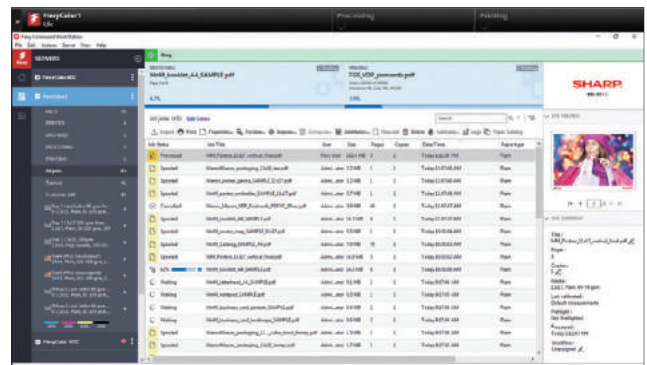

Command WorkStation features a newly improved UI for a better user experience

### Fiery Hot Folders

Fiery Hot Folders give you a quick, automated way to send files to a Fiery server using predefined settings. There's no need to input the same settings for repeat jobs or frequently used layouts. Just drag and drop print files into a Hot Folder and start printing. You can also share Hot Folders with other users on a network.

### Efficient Variable Data Printing

Fiery FreeForm™ is an efficient variable data printing (VDP) format that's ideal for mass-customised printing of mixed-media documents like flyers and direct mailers. With FreeForm, fixed images are rastered and variable elements are processed at a later stage. This minimises the processing load on the controller and speeds up the print process. The result is a print driver-based workflow that's very user-friendly. The MX-PE13 external server also supports other industry-leading VDP formats, such as PPML 3.0, PDF/VT-2, VPS, and VIPP.

### Fiery Graphics Arts Package

Included with the MX-PE13, the Fiery Graphics Arts Package enables halftone simulation, soft proofing, paper simulation, and CMYK separations. You also have the option of upgrading to the Premium Edition of the package. This further extends the level of colour management, proofing, and workflow control: ImageViewer lets you preview post-RIP raster files and adjust the colour before printing; Preflight and Postflight improve file troubleshooting; and white point editing improves simulated paper whites.

### Outstanding Colour across Applications

In demanding print environments, accurate and consistent colour is critical. Integrated Fiery colour management tools provide superior colour control out of the box. Transparencies, drop shadows, and other effects are rendered precisely every time.

### Adobe® PDF Print Engine

The MX-PE13 employs Adobe PDF Print Engine (APPE) rendering technology, which supports a native end-to-end workflow for PDFs. You can process and render PDF documents without converting them to PostScript. During PDF printing, APPE eliminates errors—even errors with transparency effects.

### Integration with Third Party and Other EFI Solutions

The Fiery open platform also supports industry standards and seamlessly integrates with existing MIS environments, third-party vendors, and other EFI MIS solutions. The MX-PE13 also integrates with web-to-print software for fast, simple VDP job submission.

	MX-PE13 external server	MX-PE14 embedded server
Memory	4 GB, 1 TB HDD	2 GB, 500 GB HDD
Command WorkStation	Operated via MFP touchscreen and remote PC	Operated via remote PC
VDP Formats	PPML 3.0, PDF/VT-2, VPS, VIPP, Fiery FreeForm	Fiery FreeForm
Adobe PDF Print Engine	Standard	–
EFI MIS, Web-to-Print	Standard	–
Sequential Print	Standard	–
Graphics Arts Package	Standard	–
Premium Edition	Option	–

# Smooth Operation

## 15.4-Inch Colour LCD Touchscreen

A large, high-resolution touchscreen provides an easy-to-use graphical interface featuring a clean design, simplified Easy UI mode, and integrated operation guide. Each user can customise the home screen by dragging and dropping icons for commonly used functions. For easy viewing at the desired angle, the control panel can be tilted front to back and side to side, and the panel's support arm can be rotated. This user-friendly operation panel pushes productivity to the next level.



## Advanced Preview

The Advanced Preview function shows scanned images on the LCD as thumbnail displays for easy confirmation and editing. It lets you check document finishes and page layout in advance, edit pages easily, and preview documents in various modes.

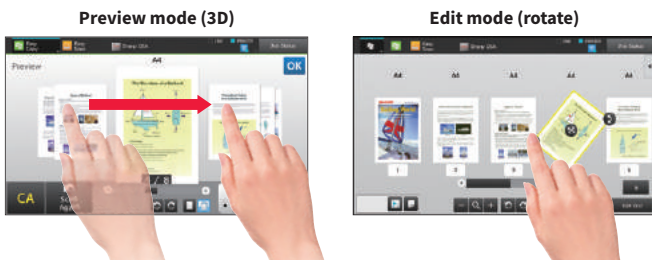

## Job Management

The MX-8090N/7090N features a Job Management screen that allows users to oversee their print jobs and have complete control of them. From here, users can easily view the status of individual jobs, change the order of jobs in the print queue, and quickly retrieve files from the MFP's hard disk. The Job Management screen also shows the scheduled start time of jobs later in the print queue, so that users can know how long the current job will take.

## Full Front Access

Particularly convenient during toner cartridge replacement, an unlikely paper jam, and other operations, full front access to all key machine components ensures easy maintenance—and maximum uptime.



## Quick Recovery from Sleep Mode

To wake the MFP from Sleep mode, just tap the LCD control panel or place a document in the DSPF. There's no need to press a dedicated button. The MFP will be ready to go.

## Direct Printing/Scanning with USB Drives

Insert a USB drive into the MFP and a print/scan command screen will automatically pop up on the LCD. Right away you can print files from the USB drive—which are displayed as thumbnails—or you can scan documents directly to the USB drive.



## Paper Setting Registration

The MX-8090N/7090N's Paper Setting Registration function allows instant recall of pre-registered media profiles. It stores up to 1,000 media profiles that include front-to-back registration settings, data on fusing temperature, and data on the type and weight of paper used. This allows identical, frequently executed jobs to be performed without the need to set the MFP each time, thereby helping to save time and ensure consistency from job to job.

## Administrator Machine Adjustments

The MX-8090N/7090N has a machine adjustment menu to enable MFP administrators (i.e., trained print room managers) to access and configure machine set-up for a total of 50 items in three areas: image quality, image position/ratio/area, and peripherals. As there is no need to call for outside service staff when making MFP adjustments, machine downtime is reduced and productivity boosted.



## Retractable Keyboard

The optional full-size retractable QWERTY keyboard slides out from beneath the control panel for fast and easy text input.



## Status Indicator

The optional Status Indicator provides status alerts, including notice of errors, via green and red LED lights that can easily be seen from a distance.

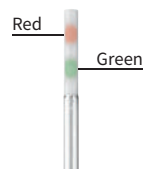



## Link to Cloud Services\*

An MX-8090N/7090N doesn't just connect to your local server. It also connects with cloud services directly from the MFP's control panel. You can upload scanned data to Google Drive™, OneDrive® for Business, SharePoint® Online, or Box—or print directly from any of them. Using a cloud service like this can save you the time and cost of setting up and managing a server within your company. Once you log in to the MFP, its single sign-on feature allows you to quickly access multiple software services without having to sign in to each one separately. It's a true time-saver that gets your document jobs finished faster.

\* Requires optional MX-AMX2. Contact a Sharp customer representative for details.

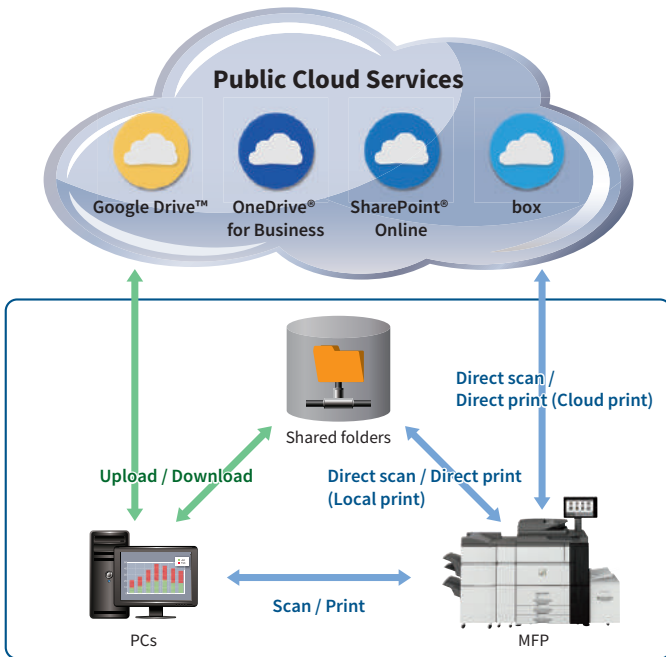

## Link with Mail Servers

Scanned data can be conveniently sent via your regular Gmail™ or Microsoft Exchange/Online account. Sending e-mail is as easy as choosing a recipient from your address book on the mail server. Scanned data that you send can be stored on the mail server with other sent items.

## Office Direct Printing

Print common Microsoft Office files without using a PC. With a MX-8090N/7090N, you can print a Word, Excel®, or PowerPoint® file directly from a cloud service, USB drive, or file server.

Note: The actual printout may look different from what is displayed on the computer screen. This function is enabled via DirectOffice™ technology.

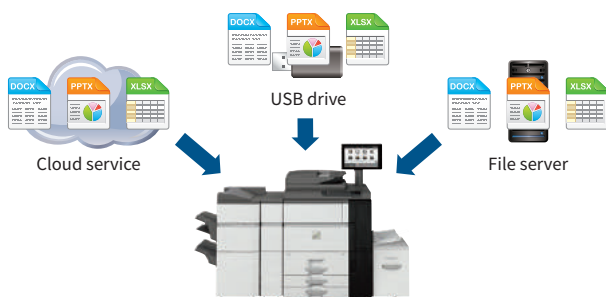

## Document Management on the Hard Disk

Processed job data can be saved in designated folders on the MX-8090N/7090N's built-in hard disk for instant recall, printing, or sending at a later time. Data for frequently used template documents can also be saved on the hard disk, enabling quick and easy output for enhanced productivity. The MX-8090N/7090N can also store PostScript print data, so that users get consistent results every time they reprint a selected data file.

## Easy Sharing of Application Files

The MX-8090N/7090N's hard disk enables files created with applications such as Word and Excel to be saved in their original file format and shared across the office network.

Note: Sharp recommends backing up data saved to the MFP's hard disk.

## Sharp OSA\* (Open Systems Architecture)

Innovative Sharp OSA technology allows you to interact with critical business and network applications right from the LCD control panel, offering a new realm of control and convenience. And since Sharp OSA utilises industry-standard network protocols, the MX-8090N/7090N can easily integrate with document management systems, enterprise resource planning software, workflow applications, and more. The latest version of Sharp OSA can reach beyond the firewall, enabling extensive system construction as well as services delivered over the Internet such as cloud services. In this way, Sharp OSA provides a foundation for cost reductions and information sharing across the entire company organisation—effectively enhancing total business efficiency.

\* Requires optional MX-AMX2 and/or MX-AMX3.

## Convert Documents via OCR

OCR capability on the MX-8090N/7090N lets you convert a scanned document into a searchable PDF file or into an editable Office Open XML (docx, xlsx, pptx) file. This means you can do speedy text searches, even with large-volume documents, and you can easily copy and paste text data into other applications.

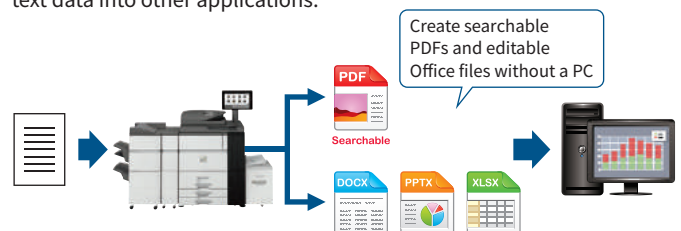

## Multicrop Function

The Multicrop function automatically creates separate files for multiple different-sized documents—such as receipts and bills—that are scanned simultaneously.

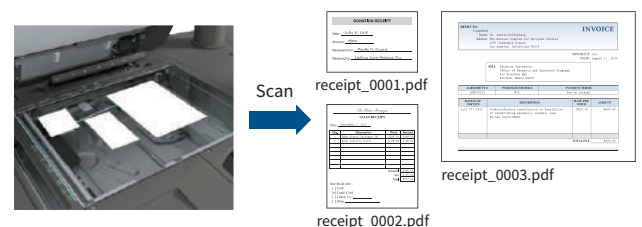

# Multi-Layered Security

## Document and Data Protection

- **Document Control** prevents unauthorised use of confidential documents by embedding copy prevention data in them  
Note: Requires optional Data Security Kit. May not work with certain types of paper, documents (such as those with a large volume of photos), or MFP settings.
- **Hidden Pattern Copy/Print** embeds a watermark onto a document
- **Tracking Information Print** prints the MFP user's name, the date, job ID, and other specifics on printouts
- Job data is automatically **encrypted** before being saved to the MFP's internal storage  
Note: Contact a Sharp customer representative for details on activating this function.
- Retained data can be **initialised** when it's time to replace the MFP, preventing the leakage of confidential information

## Network Security and Access Control

- **S/MIME** provides secure e-mail communications\*  
\* Only when e-mailing scanned data.
- **SSL** (secure sockets layer) and **IPsec** data encryption technologies ensure secure network communications
- **User authentication** covering up to 1,000 users prevents unauthorised MFP use by requiring access passwords
- **Single sign-on** brings easy access to public cloud services and internal network folders by simply logging into the MFP—there's no need to re-enter your IDs and passwords
- **Active Directory**<sup>®</sup> enables integrated management of user credentials, thereby providing a highly secure and efficient environment for system administrators

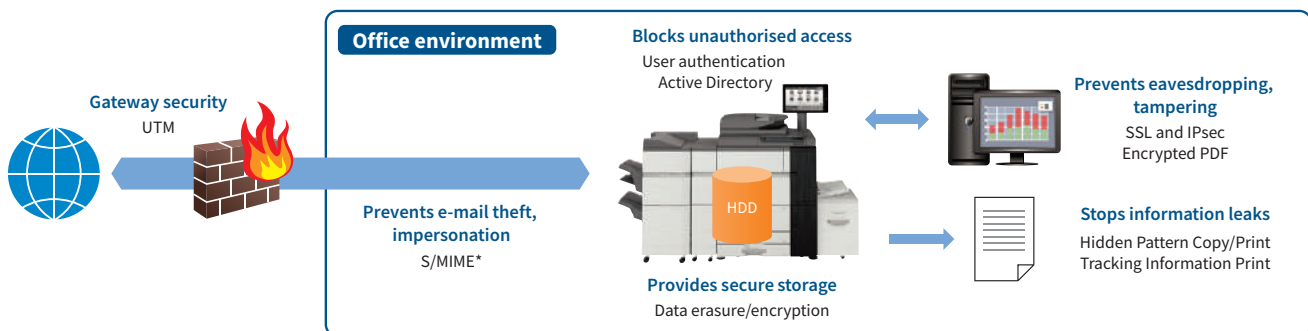

# System Configuration

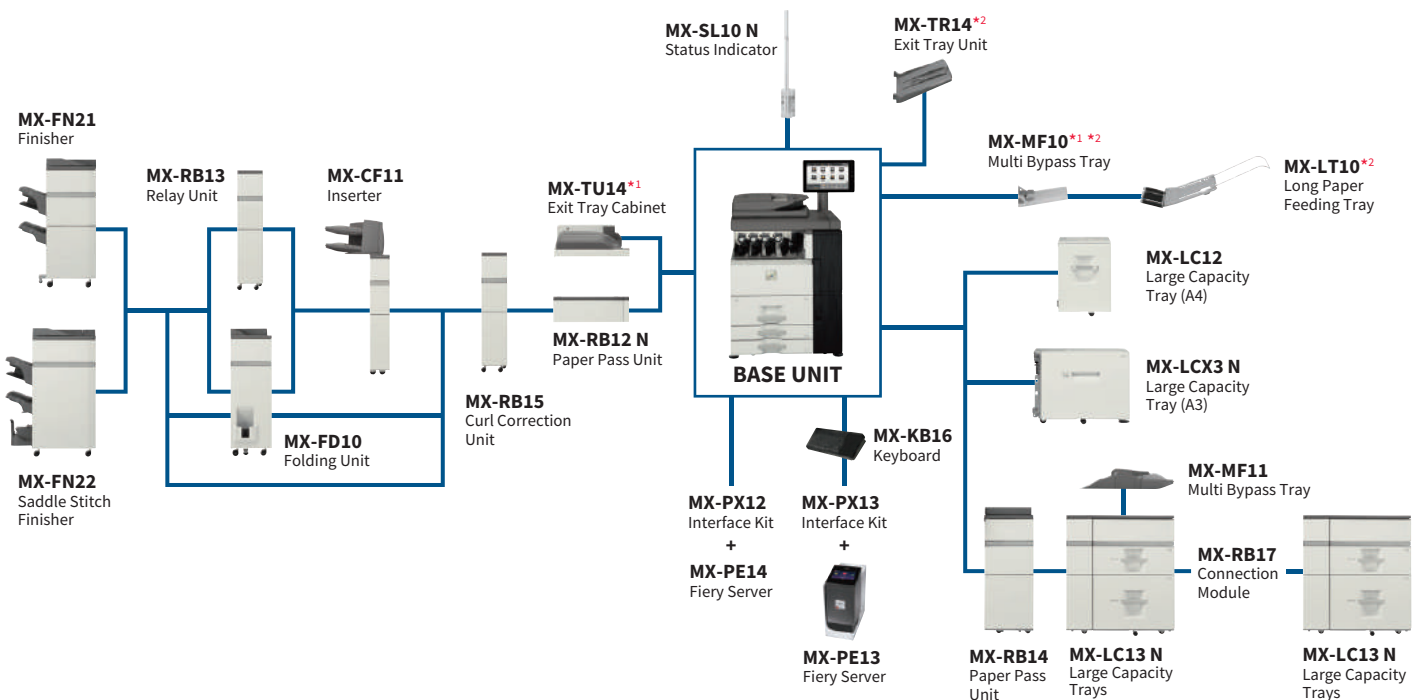

<b>MX-PN13A/B/C/D</b> Punch Module (for MX-FN21/22)	<b>AR-SU1</b> Stamp Unit	<b>MX-AMX3</b> External Account Module
<b>MX-TM10</b> Trimming Module (for MX-FN22)	<b>MX-AMX1</b> Application Integration Module	<b>MX-FR58U*3</b> Data Security Kit
<b>MX-PF10</b> Barcode Font Kit	<b>MX-AMX2</b> Application Communication Module	

\*1: Minimum required equipment.  
 \*2: Cannot be used with MX-RB14, MX-LC13 N, or MX-MF11.  
 \*3: Available at a later date.

Certain optional equipment may not be available in some areas.

# Specifications for Optional Equipment

## MX-FN21 Finisher

Paper size	Non offset	SRA3/A3 wide (13" x 19") to A5 (5 1/2" x 8 1/2")* <sup>1</sup> Custom sizes up to 330 x 488 mm (13" x 19.2")
	Offset/staple	A3 (11" x 17") to B5* <sup>2</sup> (8 1/2" x 11")
Paper weight	Non offset/offset	55 g/m <sup>2</sup> to 300 g/m <sup>2</sup> (13 lbs bond to 110 lbs cover)
	Staple	60 g/m <sup>2</sup> to 300 g/m <sup>2</sup> (16 lbs bond to 110 lbs cover)
Paper capacity (80 g/m <sup>2</sup> )	Upper tray	1,500 sheets (up to A4), 750 sheets (up to SRA3)
	Middle tray	250 sheets (up to A4), 125 sheets (up to A3), 30 sheets (up to SRA3)
	Lower tray	2,500 sheets (up to A4), 750 sheets (up to SRA3)
Stapling capacity* <sup>3</sup>		100 sheets (A4, B5), 50 sheets (A3, B4, A4* <sup>4</sup> )
Staple position		3 locations (front, rear, or 2-point stapling)
Power consumption (max.)		200 W, 350 W with MX-FD10
Power requirements		230 V, 10 A
Dimensions	With tray stored	654 x 765 x 1,040 mm (W x D x H)
	With tray extended	782 x 765 x 1,040 mm (W x D x H)
Weight (approx.)		61 kg

## MX-FN22 Saddle Stitch Finisher

Paper size	Non offset	SRA3/A3 wide (13" x 19") to A5 (5 1/2" x 8 1/2")* <sup>1</sup> Custom sizes up to 330 x 488 mm (13" x 19.2")
	Offset/staple	A3 (11" x 17") to B5* <sup>2</sup> (8 1/2" x 11")
Paper weight	Non offset/offset	55 g/m <sup>2</sup> to 300 g/m <sup>2</sup> (13 lbs bond to 110 lbs cover)
	Staple/saddle stitch	60 g/m <sup>2</sup> to 300 g/m <sup>2</sup> (16 lbs bond to 110 lbs cover)
	Folding* <sup>5</sup>	60 g/m <sup>2</sup> to 220 g/m <sup>2</sup> (16 lbs bond to 80 lbs cover)
Paper capacity (80 g/m <sup>2</sup> )	Upper tray	1,500 sheets (up to A4), 750 sheets (up to SRA3)
	Middle tray	250 sheets (up to A4), 125 sheets (up to A3), 30 sheets (up to SRA3)
	Lower tray	2,500 sheets (up to A4), 750 sheets (up to SRA3)
	Saddle stitch tray	1-5 sheets: 25 sets, 6-10 sheets: 15 sets, 11-15 sheets: 10 sets, 16-20 sheets: 5 sets
Stapling capacity* <sup>3</sup>		100 sheets (A4, B5), 50 sheets (A3, B4, A4* <sup>4</sup> )
Staple position		3 locations (front, rear, 2-point stapling)
Power consumption (max.)		200 W, 350 W with MX-FD10
Power requirements		230 V, 10 A
Dimensions	With tray stored	767 x 765 x 1,040 mm (W x D x H)
	With tray extended	896 x 765 x 1,040 mm (W x D x H)
Weight (approx.)		108 kg

## Punch Modules

Model name	For the MX-FN21/22	MX-PN13A	MX-PN13B	MX-PN13C	MX-PN13D
Number of holes		2	3/2	4/2	4 (wide)
Paper weight		55 g/m <sup>2</sup> to 256 g/m <sup>2</sup>			
Power requirements		Powered by MX-FN21/FN22 Finisher			

## MX-TM10 Trimming Module (for MX-FN22)

Paper size	SRA3/A3 wide (13" x 19") to A4 (8 1/2" x 11")* <sup>4</sup> Custom sizes up to 330 x 488 mm (13" x 19.2")
Paper weight	60 g/m <sup>2</sup> to 300 g/m <sup>2</sup> (16 lbs bond to 110 lbs cover)
Acceptable number of sheets* <sup>5</sup>	2-20 sheets (60 g/m <sup>2</sup> to 81.4 g/m <sup>2</sup> ), 2-10 sheets (more than 81.4 g/m <sup>2</sup> to 105 g/m <sup>2</sup> ), 2-3 sheets (more than 105 g/m <sup>2</sup> to 220 g/m <sup>2</sup> )
Trim width	2 mm to 20 mm in 0.1 mm increments
Power requirements	Powered by MX-FN22 Finisher
Dimensions	251 x 625 x 403 mm (W x D x H)
Weight (approx.)	32 kg

## MX-FD10 Folding Unit

Folding mode	Z-fold, C-fold, Accordion-fold, Double-fold, Half-fold
Paper size	Z-/Half-fold* <sup>6</sup> A3 (11" x 17") to A4 (8 1/2" x 11")* <sup>4</sup>
	C-/Accordion-/Double-fold A4 (8 1/2" x 11")* <sup>4</sup>
Paper capacity (80 g/m <sup>2</sup> )	Z-fold* <sup>6</sup> 30 sheets (up to A3), 10 sheets (A4)
	Half-fold* <sup>6</sup> 10 sheets (A4)
	C-/Accordion-fold 40 sheets (A4)
	Double-fold 25 sheets (A4)
Paper weight	55 g/m <sup>2</sup> to 105 g/m <sup>2</sup> (13 lbs bond to 28 lbs bond)
Power requirements	Powered by MX-FN21/FN22 Finisher
Dimensions	336 x 793 x 1,050 mm (W x D x H)
Weight (approx.)	66 kg

## MX-RB15 Curl Correction Unit

Paper size	SRA3/A3 wide (13" x 19") to A5 (5 1/2" x 8 1/2")* <sup>1</sup> Custom sizes up to 330 x 488 mm (13" x 19.2")
Paper weight	55 g/m <sup>2</sup> to 300 g/m <sup>2</sup> (13 lbs bond to 110 lbs cover)
Power requirements	Supplied by main unit
Dimensions	214 x 760 x 986 mm (W x D x H)
Weight (approx.)	19 kg

## MX-CF11 Inserter

Paper size	SRA3/A3 wide (13" x 19") to A5 (5 1/2" x 8 1/2")* <sup>1</sup> Custom sizes up to 330 x 488 mm (13" x 19.2")
Paper weight	60 g/m <sup>2</sup> to 220 g/m <sup>2</sup> (16 lbs bond to 80 lbs cover)
Paper capacity (80 g/m <sup>2</sup> ) Upper/lower tray	200 sheets/each
Power requirements	Supplied by main unit
Dimensions	With tray stored 540 x 760 x 1,276 mm (W x D x H)
	With tray extended 690 x 760 x 1,276 mm (W x D x H)
Weight (approx.)	45 kg

## MX-LC12 Large Capacity Tray (A4)

Paper size	A4, B5 (8 1/2" x 11")* <sup>7</sup>
Paper weight	60 g/m <sup>2</sup> to 220 g/m <sup>2</sup> (16 lbs bond to 80 lbs cover)
Paper capacity (80 g/m <sup>2</sup> )	3,500 sheets
Power requirements	Supplied by main unit
Dimensions	376 x 576 x 524 mm (W x D x H)
Weight (approx.)	29 kg

## MX-LCX3 N Large Capacity Tray (A3)

Paper size	SRA3/A3 wide (12" x 18") to B5* <sup>2</sup> (8 1/2" x 11")
Paper weight	60 g/m <sup>2</sup> to 220 g/m <sup>2</sup> (16 lbs bond to 80 lbs cover)
Paper capacity (80 g/m <sup>2</sup> )	3,000 sheets
Power requirements	Supplied by main unit
Dimensions	670 x 570 x 525 mm (W x D x H)
Weight (approx.)	50 kg

## MX-LC13 N Large Capacity Trays

Paper size	SRA3/A3 wide (13" x 19") to B5 (7 1/4" x 10 1/2")* <sup>8</sup> Custom sizes up to 330 x 488 mm (13" x 19.2")
Paper weight	55 g/m <sup>2</sup> to 300 g/m <sup>2</sup> (13 lbs bond to 110 lbs cover)
Paper capacity (80 g/m <sup>2</sup> ) Upper/lower tray	2,500 sheets/each
Power consumption	900 W
Power requirements (max.)	230 V, 10 A
Dimensions	895 x 763 x 986 mm (W x D x H)
Weight (approx.)	131 kg

## MX-MF10 Multi Bypass Tray

Paper size	SRA3/A3 wide (13" x 19") to A5 (5 1/2" x 8 1/2")* <sup>1</sup> Custom sizes up to 330 x 488 mm (13" x 19.2")
Paper weight	55 g/m <sup>2</sup> to 300 g/m <sup>2</sup> (13 lbs bond to 110 lbs cover)
Paper capacity (80 g/m <sup>2</sup> )	100 sheets
Dimensions	With tray stored 180 x 416 x 316 mm (W x D x H)
	With tray extended 465 x 416 x 117 mm (W x D x H)
	With auxiliary guide extended 579 x 416 x 117 mm (W x D x H)
Weight (approx.)	3 kg

## MX-MF11 Multi Bypass Tray (for MX-LC13 N)

Paper size	SRA3/A3 wide (13" x 19") to A5 (5 1/2" x 8 1/2")* <sup>1</sup> Custom sizes up to 330 x 488 mm (13" x 19.2")
Paper weight	55 g/m <sup>2</sup> to 220 g/m <sup>2</sup> (13 lbs bond to 80 lbs cover)
Paper capacity (80 g/m <sup>2</sup> )	500 sheets
Power requirements	Powered by MX-LC13 N Large Capacity Trays
Dimensions	With tray stored 705 x 556 x 203 mm (W x D x H)
	With tray extended 878 x 556 x 203 mm (W x D x H)
Weight (approx.)	18 kg

## MX-LT10 Long Paper Feeding Tray

Paper size	Width 90 mm to 305 mm
	Length 489 mm to 1,300 mm
Paper capacity	1 sheet
Dimensions	With tray stored 338 x 195 x 107 mm (W x D x H)
	With tray extended 581 x 195 x 103 mm (W x D x H)
Weight (approx.)	1 kg

Note: All specifications relating to paper capacity refer to 80 g/m<sup>2</sup> paper.

\*1: Only short-edge feeding can be used with A5 (5 1/2" x 8 1/2") paper.

\*2: Only long-edge feeding can be used with B5 paper.

\*3: Using 80 g/m<sup>2</sup> paper, can include back and front covers (total of 2 sheets) of heaviest paper that can be stapled.

\*4: Only short-edge feeding can be used with A4 (8 1/2" x 11") paper.

\*5: Can include a single cover sheet of 300 g/m<sup>2</sup> or less.

\*6: Z-fold and half-fold pages are ejected from the finisher (MX-FN21/FN22).

\*7: Only long-edge feeding can be used with A4 and B5 (8 1/2" x 11") paper.

\*8: Only short-edge feeding can be used with 7 1/4" x 10 1/2" paper.

## SPECIFICATIONS (tentative)

### General

Type	Console
Engine speed	A4 (8 1/2" x 11")*1: Max. 80/70 ppm A3 (11" x 17"): Max. 45/41 ppm SRA3: Max. 43/39 ppm
Control panel display	15.4-inch colour LCD touchscreen
Paper size	Max. SRA3/A3 wide (13" x 19"), min. A5 (5 1/2" x 8 1/2")*2
Paper capacity (80 g/m <sup>2</sup> )	Standard: 3,100*3 sheets (1,200-sheet tray, 800-sheet tray, 500-sheet tray x 2, and optional 100-sheet multi-bypass tray) Maximum: 13,500 sheets (3,000 sheets & optional 2 x 2,500-sheet tray x 2 and 500-sheet multi-bypass tray) Tray 1&2: 60 g/m <sup>2</sup> to 105 g/m <sup>2</sup> (16 lbs bond to 28 lbs bond) Tray 3&4: 60 g/m <sup>2</sup> to 220 g/m <sup>2</sup> (16 lbs bond to 80 lbs cover) Multi-bypass tray (MX-MF10): 55 g/m <sup>2</sup> to 300 g/m <sup>2</sup> (13 lbs bond to 110 lbs cover) Multi-bypass tray (MX-MF11): 55 g/m <sup>2</sup> to 220 g/m <sup>2</sup> (13 lbs bond to 80 lbs cover) Large capacity tray (MX-LC12, MX-LCX3 N): 60 g/m <sup>2</sup> to 220 g/m <sup>2</sup> (16 lbs bond to 80 lbs cover) Large capacity trays (MX-LC13 N): 55 g/m <sup>2</sup> to 300 g/m <sup>2</sup> (13 lbs bond to 110 lbs cover)
Paper weight	
Warm-up time*4	90 sec.
Memory	6 GB (copy/print shared) 1 TB HDD*5
Power requirements	220 V to 240 V, 8 A, 50/60 Hz (10 A plug x 2)
Power consumption	Max. 3.84 kW (220 V to 240 V)
Dimensions (W x D x H)*6	982 x 768 x 1,530 mm (38 43/64" x 30 1/4" x 60 1/4")
Weight (approx.)	224 kg (493.9 lbs)

### Copier

Original paper size	Max. A3 (11" x 17")
First copy time*7	Full colour: 5.1/5.6 sec. B/W: 3.7/4.0 sec.
Continuous copy	Max. 9,999 copies
Resolution	Scan (colour): 600 x 600 dpi Scan (B/W): 600 x 600 dpi, 600 x 400 dpi Print (colour): 600 x 600 dpi, 9,600 (equivalent) x 600 dpi (depending on copy mode) Print (B/W): 1,200 x 1,200 dpi, 600 x 600 dpi, 9,600 (equivalent) x 600 dpi (depending on copy mode) Equivalent to 256 levels
Gradation	Equivalent to 256 levels
Zoom range	25% to 400% (25% to 200% using DSPF) in 1% increments
Preset copy ratios	Metric: 10 ratios (5R/5E), inch: 8 ratios (4R/4E)

### Network Scanner

Scan method	Push scan (via control panel) Pull scan (TWAIN-compliant application)
Scan speed*8 (colour & B/W)	One-sided: Max. 100 originals/min. Two-sided: Max. 200 originals/min.
Resolution	Push scan: 100, 150, 200, 300, 400, 600 dpi Pull scan: 75, 100, 150, 200, 300, 400, 600 dpi 50 dpi to 9,600 dpi via user setting*9
File formats	TIFF, PDF, PDF/A-1a, PDF/A-1b, encrypted PDF, compact PDF*10, JPEG*10, XPS, searchable PDF, OOXML (docx, xlsx, pptx), text (TXT [UTF-8]), rich text (RTF)
Scan destinations	Scan to e-mail/FTP server/network folder (SMB)/USB drive/HDD

- Design and specifications are subject to change without prior notice.
- Command WorkStation, the EFI logo, Fiery, and the Fiery logo are registered trademarks of Electronics for Imaging, Inc. in the US and/or certain other countries. EFI and FreeForm are trademarks of Electronics for Imaging, Inc. in the US and/or certain other countries. Adobe, PostScript 3, and Adobe PDF Print Engine are either registered trademarks or trademarks of Adobe Systems Incorporated in the US and/or other countries. Microsoft, OneDrive, SharePoint, Excel, PowerPoint, Active Directory, Windows, and Windows Server are either registered trademarks or trademarks of Microsoft Corporation in the US and/or other countries. Google Drive and Gmail are trademarks of Google LLC. The Google Drive trademark is used with permission from Google LLC. Box is a trademark, service mark, or registered trademark of Box, Inc. Mac is a trademark of Apple Inc., registered in the US and other countries. PCL is a registered trademark of Hewlett-Packard Company. Intel Core i5 and Celeron are trademarks of Intel Corporation or its subsidiaries in the US and/or other countries. DirectOffice is a product of CSR Imaging US, LP. DirectOffice is a trademark of CSR Imaging US, LP, registered in the US and other countries, used with permission. All other brand names and product names may be trademarks or registered trademarks of their respective owners.

DIRECTOffice™

### Document Filing

Document filing capacity*11	Main and custom folders: 35,000 pages or 5,000 files Quick file folder: 10,000 pages or 1,000 files
Stored jobs	Copy, print, scan
Storage folders	Quick file folder, main folder, custom folder (max. 1,000 folders)
Confidential storage	Password protection (for main and custom folders)

### Network Printer

Resolution	1,200 x 1,200 dpi, 600 x 600 dpi, 9,600 (equivalent) x 600 dpi
Interface	USB 2.0, 10Base-T/100Base-TX/1000Base-T
Supported OS	Windows Server® 2008, Windows Server® 2008 R2, Windows Server® 2012, Windows Server® 2012 R2, Windows Server® 2016, Windows® 7, Windows® 8.1, Windows® 10, Mac OS 10.6, 10.7, 10.8, 10.9, 10.10, 10.11, 10.12, 10.13
Network protocols	TCP/IP
Printing protocols	LPR, Raw TCP (port 9100), POP3 (e-mail printing), HTTP, FTP for downloading print files, IPP, SMB, WSD
PDL	PCL 6 emulation, Adobe® PostScript® 3™
Available fonts	80 fonts for PCL, 139 fonts for Adobe PostScript 3

### Fiery® Server (option)

	MX-PE13	MX-PE14
Type	External server	Embedded server
Interface kit	MX-PX13	MX-PX12
System software	Fiery FS300 Pro	Fiery FS300
Operating system	Windows® 10	Linux
CPU	Intel® Core™ i5-4570, 3.6 GHz	Intel Celeron® G1820, 2.7 GHz
Memory	4 GB RAM, 1 TB HDD	2 GB RAM, 500 GB HDD
Resolution	1,200 x 1,200 dpi, 600 x 600 dpi (PS, PCL)	
Supported OS	Windows Server® 2008, Windows Server® 2008 R2, Windows Server® 2012, Windows Server® 2012 R2, Windows Server® 2016, Windows® 7, Windows® 8.1, Windows® 10, Mac OS 10.9, 10.10, 10.11, 10.12, 10.13	
Network protocols	TCP/IP, LDAP, iPrint thru LPR	
Interface	Gigabit Ethernet	
Printing protocols	LPD, PAP, SMB, port 9100, IPP 1.1, FTP printing, print via e-mail, WSD	
PDL	Adobe PostScript 3	
Available fonts	138 fonts for Adobe PostScript 3	
Power requirements	100 V to 240 V, 50/60 Hz	
Power consumption	Max. 0.35 kW	Max. 0.18 kW
Dimensions (W x D x H)	235 x 464 x 528 mm (9 17/64" x 18 9/32" x 20 51/64")	90 x 272 x 297 mm (3 35/64" x 10 23/32" x 11 45/64")
Weight (approx.)	17 kg (37.5 lbs)	6 kg (13.3 lbs)

- \*1: Long-edge feeding. \*2: Only short-edge feeding can be used with A5 (5 1/2" x 8 1/2") paper. \*3: Paper capacity on minimum required equipment. \*4: In a standard measurement environment. May vary depending on operating conditions and environment. \*5: HDD capacity depends on procurement and sourcing status. \*6: Including adjusters and protuberances. \*7: Long-edge feeding of A4 (8 1/2" x 11") sheets from 2nd paper tray, using document glass, without Auto Colour Selection and Auto Colour mode, MFP in fully ready condition. May vary depending on operating conditions and environment. \*8: Based on Sharp's A4 standard chart, using document feeder and long-edge feeding. Using factory default settings with Auto Colour Selection off. Scan speed will vary depending on the type of document and the scan settings. \*9: Resolution will vary depending on the size of the scanned area. \*10: Colour/greyscale only. \*11: Storage capacity will vary depending on the type of document and the scan settings.

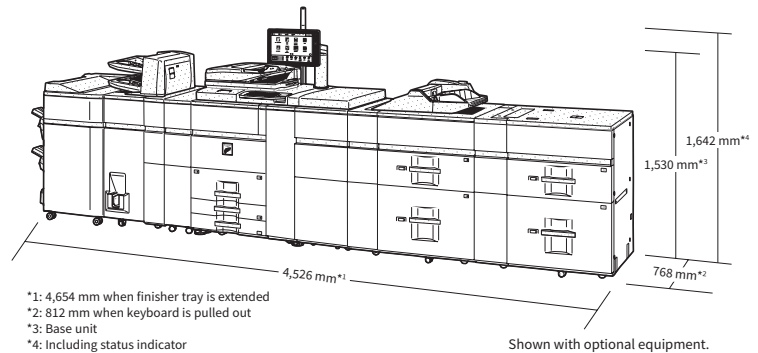

- \*1: 4,654 mm when finisher tray is extended
- \*2: 812 mm when keyboard is pulled out
- \*3: Base unit
- \*4: Including status indicator

Distributed by: